

Step by Step Guide to installing Marmox Systems



Fast, safe, easy to install and totally waterproof!

 **marmox**
Waterproofing & Insulation Solutions
Marmox gives you more!



- **Product information**
- **Installation guides**
- **Technical information**
- **Book a CPD**
- **Industry news**
- **Find a stockist**



@MarmoxUK

www.marmox.co.uk



/marmoxukltd

marmox **MSP360** Premium Adhesive & Sealant

New



MSP360 is our new ultra-high performance, clear adhesive and sealant. Providing instant grab, MSP360 can be used both externally and internally for a wide range of applications, and is compatible with all Marmox products.

MSP360 is made using the latest Advanced Modified Silane-Polymer (MSP) Technology, meaning it can be applied to wet surfaces – and will even cure underwater.

- Polystyrene
- Brick/Masonry
- Concrete/Plaster
- Metals (incl. Lead)
- Plastics
- Woods
- Tiles
- Glass/Mirrors
- PVCu
- Ceramics/Stone



Strong bond



Instant grab



Quick drying



Wet surfaces



Anti pick



UV/Weather resistant



Sound absorbing



Food grade

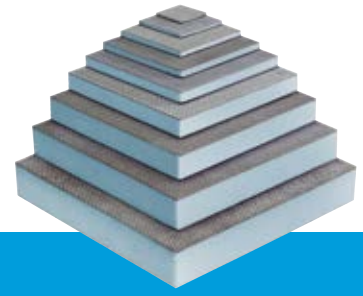

Contents

marmox **multiboard**

Waterproofing • Insulating • Drylining

General	4
Technical Information	6
Applying Multiboard to Walls	8
Applying Multiboard to Floors	12
Boxing in pipework	14
Applying Multiboard around curves	15
Creating a slope	16
Panel a bath	18
Dry lining	19



marmox **soundBoard**

Impact sound & thermal floor insulation

Acoustic and thermal insulation for floors	20
---	-----------



marmox **showerlay** 360

Floor level shower base

Pre-sloped tileable shower bases	22
---	-----------



marmox

Niches	26
Accessories	27
Company information	31



More than just a tile backer board!

Marmox Multiboard is a lightweight, high performance tile backer board, offering the best long-term adhesion in its class. Additionally it is a CE marked internal insulation board that can be plastered therefore it is an alternative to laminated thermal plasterboard.

Thicknesses range from 4mm to 60mm allowing Marmox Multiboard to be used to provide a platform for tiling, a waterproof barrier, thermal insulation on walls, floors and ceilings and the thicker boards can be used to construct shelving units and bathroom furniture.

What is Multiboard made of?

Marmox Multiboard consists of a core of extruded polystyrene bonded between layers of fibreglass reinforced polymer concrete. This layer provides the perfect level of porosity to bond with tile adhesive or plaster. The extruded polystyrene layer provides insulation and makes the board completely impermeable to water. The combination of the rigid outer shell and the XPS core which absorbs lateral movement makes the board an effective decoupling layer.

Internal wall insulation...and for floors

Marmox Multiboard as an internal wall insulation board. It is particularly popular in providing insulation to solid masonry walls without cavities and where insulation on the outside of the building is impractical or would affect the look of the building. Using Marmox Multiboard to line what used to be a cold wall will also significantly reduce the surface condensation on that wall.

XPS (extruded polystyrene) is one of the most effective insulation materials available and also has the benefit that its thermal insulation properties are not affected whatsoever by wet or damp conditions.



- Fully waterproof
- Highly insulating
- Ready to tile or plaster
- Holds 100kg/m² on walls
- 40 tonnes/m² on floors
- Lightweight to handle
- Easy to cut

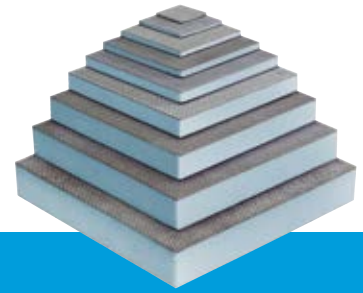

Other softer insulation materials absorb water and when that happens they effectively stop providing insulation.

High strength tile backer board

Multiboard's unique and patented textured concrete surface provides a strong key which enables tiles of very high weights to be safely fitted on walls.

The maximum tiling weight is limited only by the capacity of the tile adhesive and the wall structure the board is fixed to. When fixed with a continuous bed of adhesive, the adhesive itself will crumble before the bond between the board and the tiling breaks, therefore the loading capacity typically far exceeds 100kg/m². The compressive strength of all thicknesses of Marmox Multiboard, once tiled, is 40 tonnes/m².

Underfloor heating

Up to 40% of heat generated by underfloor heating gets lost through concrete floors.

Marmox Multiboard acts as a barrier, reflecting the heat upwards into the room and reducing the heat loss. This will dramatically reduce heating costs because the heating can be set at a much lower temperature to feel the same effects.

Using Multiboard with electric under-tile heating, the desired room temperature can be achieved in as little as 20 minutes as opposed to nearly two hours when it is not used. This is the reason that insulation boards are recommended for use by most electric underfloor heating manufacturers.

Waterproofing



Being completely waterproof, as opposed to merely water resistant, means that no water at all can be absorbed into the core of the Multiboard. This means that they will not bend, bow or distort in the way that plasterboard can, for example.

Multiboard can be used as a waterproofing tile backer board in many situations including bathrooms, wetrooms, steam rooms and even swimming pools.

Environment and Sustainability

Our factory operates a zero waste policy where all waste material from Marmox Multiboard production is recycled into other less formulation critical products.

In accordance with EN13164 and directive EC1272/2008, the product is not classified as hazardous. It is HCFC and HBCD free and does not contain any REACH hazardous substances.

WARNING: Do not use solvent based adhesives/sealants with Marmox products.

Technical data

Compressive Strength (at 10% deformation)	(EN 826)	400kPa (40 tonnes/m²)
Thermal Conductivity	(EN 13164)	0.034 Watts/mK
Water Absorption of XPS	(EN 12087)	<0.7%
Coefficient of Thermal Expansion	(ASTM D696)	8x10⁻⁶ k⁻¹
Flammability	(EN 476-6,7)	Class 0
	(EN 13501)	Class E
ODP		zero
GWP		0.29
Declaration of Performance (CE)	XPS-EN13164-T1-CS(10\Y)400-CC(2/1/10)115-WL(T)3	

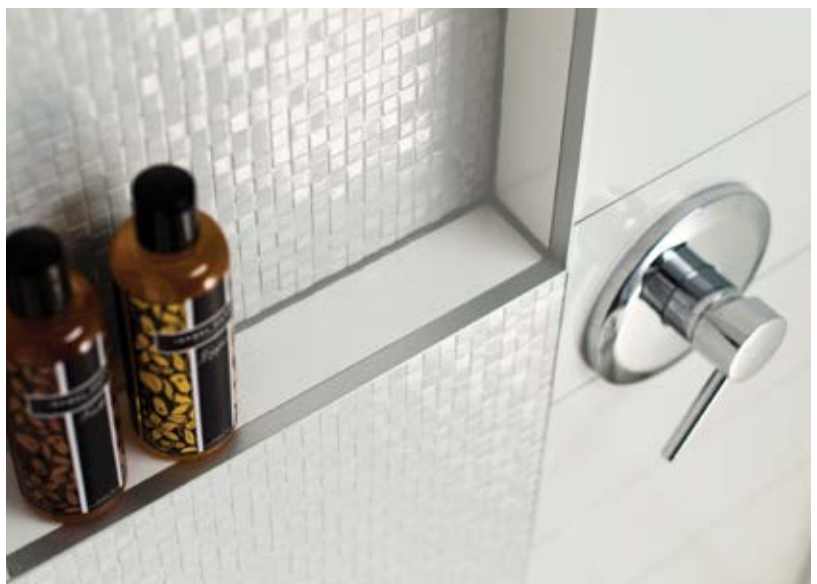

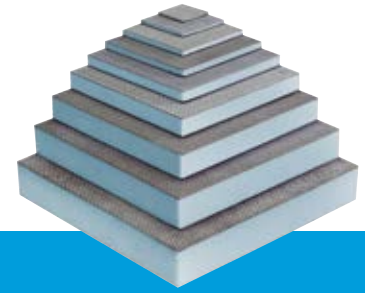

Multiboard sizes *(for square meterage see table below)*

thickness (mm)	width (mm)	length (mm)	weight (kg)	R value (m ² .k/w)
4.0	600	1250	2.30	0.11
6.0	600	1250	2.40	0.17
10.0	600	1250	2.70	0.28
10.0	600	2500	5.40	0.28
12.5	600	1250	2.80	0.35
12.5	600	2500	5.60	0.35
20.0	600	1250	3.10	0.56
20.0	600	2500	6.20	0.56
30.0	600	1250	3.40	0.83
30.0	600	2500	6.80	0.83
40.0	600	1250	4.00	1.11
40.0	600	2500	8.00	1.11
50.0	600	1250	4.20	1.39
50.0	600	2500	8.40	1.39
60.0	600	1250	4.50	1.67
60.0	600	2500	9.00	1.67
12.5	1200	2400	11.00	0.35
20.0	1200	2400	12.00	0.56

Convert to square metres

marmox Thickness (mm)	Short Multiboard (per carton)		Short Multiboard (per pallet)		Long Multiboard (per pallet)	
	Number of boards	Square metres	Number of boards	Square metres	Number of boards	Square metres
4	10	7.5	300	225	/	/
6	8	6	240	180	/	/
10	6	4.5	150	112.5	75	112.5
12.5	6	4.5	120	90	60	90
20	5	3.75	80	60	40	60
30	4	3	60	45	60	90
40	3	2.25	45	33.75	45	67.5
50	2	1.5	36	27	36	54
60	2	1.5	30	22.5	30	45

Individual board sizes (m²): Short board .75, Long board 1.5, Big board 2.88

Multiboard - solid walls with screws/washers

Marmox Multiboard can be applied directly to solid walls simply with screws and washers. Multiboard is an ideal way to cut down on the heat lost through solid walls. Buildings with solid walls and without cavity will feel a considerable difference in room temperature when coated with Marmox Multiboard.

Multiboard is very easy to install, as it is lightweight and very easy to cut to size with a saw or knife. Multiboard can be fixed vertically or horizontally onto walls and you can also fix to the ceiling.

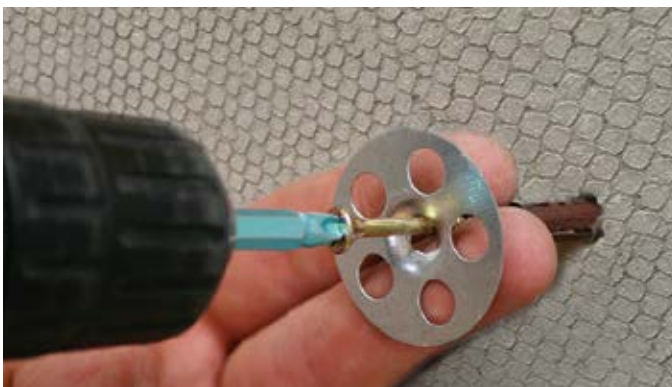

Preparation

Measure the Multiboard and cut to size. It is very easy to cut with a saw or knife.

Fixing

Offer the Multiboard up to the wall and use Marmox washers and screws. Screws should generally be at least 20mm longer than the thickness of the board. Be aware of any electrical wires or pipe work that may be in the wall.

Short boards – 3 rows of 3 fixings (1 inch from the edges)

Long boards – 3 rows of 5 fixings (1 inch from the edges)

Joints

Be sure to tape all the joints with Marmox Reinforcing Tape.

If the area needs to be waterproof be sure to tape all of the corners, joints and screw holes with Marmox Self Adhesive Waterproof tape.

Final touch

The boards are now ready to be tiled.



Multiboard - stud frames

Lots of modern buildings are made using timber or metal stud frames that are then lined with plaster board or wooden panels. Marmox Multiboard is the ideal alternative for lining such walls because, unlike wood or plaster, Multiboard is fully waterproof making it perfect for wetrooms, bathrooms and kitchens. Multiboard also offers high thermal insulation that can benefit every room in the house by significantly reducing your heating loss.

Multiboard is suitable for tiling or for plastering.



Preparation

Marmox Multiboard is available in thicknesses Ranging from 4mm to 60mm.

- 10 & 12.5mm thick boards are fixed directly to timber or metal frame at 300mm centres
- 20mm and thicker boards are fixed directly to timber or metal frame at 600mm centres
- All board edges must be supported.

Fixing

Boards should be fixed to the stud with a screw + washer every 300mm

- 20mm + thicker short board = 5 fixings down each long side (i.e. 10 fixings per board)
- 10 + 12.5mm short board = 5 fixings down each side and also into the stud running through the middle of the board (i.e. 15 fixings per board)

Joints

Be sure to tape all the joints with Marmox Reinforcing Tape (as shown middle left).

If the area needs to be waterproof be sure to tape all the corners and joints with Marmox Self Adhesive Waterproof tape.

Final touch

The boards are now ready to be tiled.

Multiboard - solid walls with adhesive

No battens required! Multiboard can be fixed to a solid wall of brick or block, even existing tiles, and then simply plastered or tiled. As thin as 4mm Multiboard can be used on walls and therefore does not take up much valuable living space.

The Multiboard can be stuck to walls using a flexible cement based tile adhesive. It is recommended to remove all existing tiles or boarding that is currently on the wall before sticking the Multiboard to the wall. If it is impractical to remove the boarding or tiles, then be sure to also screw fix through to the main supporting wall or timber frame.



Preparation

Make sure the wall has been dusted down and is free from any protrusions.

Any thickness can be used on walls.

Fixing

Comb a cement based flexible adhesive (C2) over the whole surface of the Multiboard or the wall itself.

6/8mm trowel

Push firmly onto the wall. It's ideal to stagger the joints.

Joints

Be sure to tape all the joints with Marmox Reinforcing Tape.

For waterproofing be sure to tape all the corners and joints with Marmox Self Adhesive Waterproof tape.

Final touch

The boards are now ready to be tiled.



Multiboard - solid walls with fixing dowels

Another way to fix Multiboard to a solid wall is with Marmox fixing dowels. This method is particularly useful if the wall is so uneven that it makes full surface bonding impractical.

This method involves first making small holes through the board to mark the positions of the dabs then fixing to the wall with dabs of tile adhesive. After the adhesive has cured, the Marmox fixing dowels are used to secure the boards in position. These dowels are fully plastic so therefore corrosion resistant providing long term stability even in the wettest of environments.



Preparation

Measure the Multiboard and cut to size. It is very easy to cut with a saw or knife.

12.5mm Multiboard (or thicker) should be used on walls with this method.

Fixing

Drill fixing holes through the Multiboard into the solid wall.

Short boards - 5 fixings (1 in each corner, 1 in the middle)

Long boards - 8 fixings (6 around edges, 2 in the middle)

Put a dab of cement based flexible tile adhesive (C2) over the holes on the Multiboard and then offer up to the wall. Push firmly and then level with a spirit level.

Push in the white dowel and then hammer in the red pin

Joints

Tape all the joints with Marmox Reinforcing Tape.

If the area needs to be waterproof be sure to tape all the corners and joints with Marmox Self Adhesive Waterproof tape.

Assurance

This method is approved and guaranteed by Marmox UK but is not one of the applications assessed by BBA and is therefore not covered by the certificate.

Multiboard - floors with adhesive

To significantly cut down on heat loss through the floor (ie, to improve the U-value) Marmox Multiboard should be used to cover all areas before tiling. As well as reducing heat loss through the floor, Marmox Multiboard offers the ideal base to tile onto, providing effective decoupling, ensuring a smooth level floor when the tiles are laid.

Being fully waterproof they also guarantee that any water that makes its way through the tile adhesive will go no further. Once tiled Multiboard will support a weight of 40 tonnes/m² on floors.

Most underfloor heating companies recommend using this type of insulation.



Preparation

Make sure the floor is dust/dirt free and level. Any loose floor boards should be secured down.

On a concrete or sheet timber floor, any thickness of Multiboard can be used. For adhering to traditional floorboards, 10mm Multiboard or thicker must be used.

Fixing

Comb a full bed of cement based flexible adhesive over the surface of the Multiboard or onto the floor.

6/8mm trowel

20mm trowel for uneven floors

Push firmly onto the floor, being sure to stagger the joints.

Joints

Tape all the joints with Marmox Reinforcing Tape.

For waterproofing be sure to tape all the corners, joints and screw holes with Marmox Self Adhesive Waterproof tape instead of the reinforcing tape.

Final touch

The Multiboard is now ready to be covered.

Tiles – Tile directly onto the Multiboard. Small mosaics are not suitable for use on Multiboard on the floor, tiles should be at least 50mm x 50mm.

Under Floor Heating wire – Lay directly onto the Multiboard and then tile.



Multiboard - wooden floors with screws/washers



Preparation

Secure down any loose floor boards. Any thickness Multiboard can be used on sheet flooring with screws and washers. However it is not recommended to use screws and washers on traditional floorboards.

Fixing

Use a screw and Marmox washer at every 300mm. Make sure the screws embed into the floor by at least 20mm.

Short boards - 3 rows of 4 fixings (1 inch in from the edges)

Joints

Tape all the joints with Marmox Reinforcing Tape.

For waterproofing be sure to tape all the corners, joints and screw holes with Marmox Self Adhesive Waterproof tape instead of the reinforcing tape.

Final touch

The Multiboard is now ready to be covered.

Tiles – Tile directly onto the Multiboard. Small mosaics are not suitable for use on Multiboard on the floor, tiles should be at least 50mm x 50mm

Under Floor Heating wire – Lay directly onto the Multiboard and then tile.

Multiboard - Pipe Boxing

Marmox Multiboard is extremely versatile and the ideal way to waterproof a bathroom or wetroom. To make things even easier, Marmox Pipe-boxing Multiboard and Curved Multiboard help to make creative ideas more achievable.

Marmox pipe-boxing comes in flat sheets that bend to a 90° angle and seals with a self adhesive tape. Curved Multiboard comes in flat boxes and simply bends to the required curve ready for mosaic tiling.



Preparation

Measure out the pipe work that needs covering to ensure the correct size pipe boxing. Multiboard pipe-boxing is available in 4 different sizes:

- 150mm + 150mm wide, 1250mm long
- 200mm + 200mm wide, 1250mm long
- 300mm + 300mm wide, 1250mm long
- 400mm + 200mm wide, 1250mm long

Fixing

- 1) Cut the pipe boxing to the required size.
- 2) Peel off the backing tape from the self-adhesive strip and fold the board to a 90° angle.
- 3) Push on the wall brackets (as shown in middle left)

Use 4 wall brackets per 1250mm board (2 either side)

- 4) Run a bead of Marmox Multibond along the edges of the pipe boxing and offer it up to the wall.

- 5) Then secure the wall brackets with screws.

Joints

The pipe boxing can be stacked up to the necessary height, just put a bead of Marmox Multibond where the Multiboard meets. Be sure to tape all the joints with Marmox Reinforcing Tape or Marmox Self Adhesive Waterproof tape in wet areas.

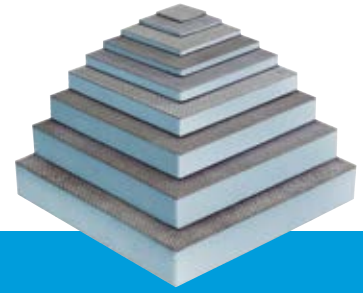

Multiboard - Curved



Preparation

The curved Multiboard comes flat packed and can be easily bent to the required radius. Simply measure and cut to the required size.

Fixing

Ideally the best way to bend the curved Multiboard is to have the slits on the inside of the circular shape at all times and the smooth edge on the outside. Fix to a wooden framework with screws and Marmox washers or stick to Multiboard with Marmox Multibond.

Joints

Be sure to tape all the joints with Marmox Reinforcing Tape.

Note: It is also possible to bend the curved Multiboard with the slits on the outside. However if this is done then a flexible cement based tile adhesive needs to be used to fill out all of the slits on the surface and then a sheet of fibreglass mesh (as shown middle left) should be laid over to offer support.

Final touch

The curved Multiboard is now ready to be tiled.

Sloped Multiboard (on balconies)

Made from the same material as standard Multiboard, Sloped Multiboard is a 1200 x 1200mm panel with a uniform gradient in one plane. The thick edge is 33mm thick and this tapers down to 10mm at the opposite edge.

The Marmox Multiboard range has been assessed (to ASTM C666-03) confirming that it is suitable for use as an external tile backer board. The board's low-porosity polymer concrete coating is weather resistant including being resistant to freeze/thaw and moisture damage, and the core is completely impermeable to water. This makes it ideal to be used externally either on walls or floors as a lightweight tile backer board. The board's coefficient of thermal expansion has been engineered to be similar to that of ceramic tiles, so expansion and contraction due to external temperature variation will be the same in both the tiles and the Marmox base. This will consequently not result in cracks in the grout or any stresses developing in the tile adhesive.

Sloped Multiboard was developed initially as a board for outdoor balconies and terraces. It provides an instant slope to a tiled floor to ensure effective drainage in addition to decoupling, waterproofing and thermal insulation. The 10mm to 33mm thickness is so that a 20mm thick standard Multiboard can be fixed underneath a sloping board (+ 3mm of adhesive) which would then have a total height of 33mm so the next Sloped Multiboard can be butted up to it.

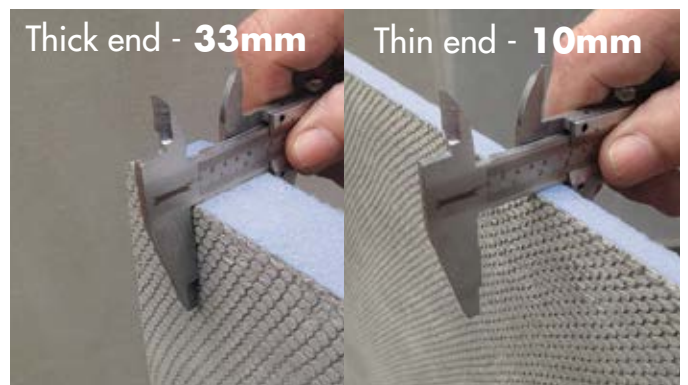



Sloped Multiboard (shower floors)

The picture below shows that a constant slope can be created by fixing a layer of 20mm thick Marmox Multiboard under the next Sloped Multiboard, this can be repeated to create an almost infinite sloped surface.

Communal showers often have a drainage channel placed at the wall floor junction with the whole floor gently sloping towards that wall. Marmox Sloped Multiboard can be used to create such a slope, leading to a proprietary drainage channel. It is simply bonded to the floor with cement-based tile adhesive and the junction between the board and the drainage is channel subsequently sealed.

Preparation

Sloped-Multiboard needs to be fully supported. It cannot span joists and should be on a flat level surface.

Fixing

Comb a full bed of cement based tile adhesive over the surface of the Sloping Multiboard or onto the floor.

6/8mm trowel

20mm trowel for uneven floors

- 1)** Push firmly onto the floor.
- 2)** Sit the Sloping Multiboard side by side with the thin edge closest to the wall or butted up to where the drain will be.
- 3)** It is possible to trim down the edge to fit with the suitable drain.
- 4)** To extend the area out further, lay down standard 20mm Multiboard and then sit another Sloping Multiboard on top (as shown bottom left). Stick the Multiboard together with flexible cement based tile adhesive.

Joints

Tape all the joints with Marmox Reinforcing Tape.

For waterproofing be sure to tape all the corners and joints with Marmox Self Adhesive Waterproof tape instead of the reinforcing tape.



Multiboard - Bath panel kit

When you've finished tiling your walls and floors with Multiboard the obvious next step is to tile around the bath with matching tiles. In order to do this effectively, the Marmox Multiboard bath panel kit offers the solution. Simply cut the side and end panels to the correct length, place into position and then adjust the height of the feet supplied. With Multiboard it is easy to cut out a panel for pipe work access! They are then ready to be tiled.

Included in the kit is Marmox S/A Waterproof Tape, long and short bath panels with feet and a tube of Marmox Multibond.



Included in the kit

product	size
Bath end panel	600mm x 800mm
Bath side panel	600mm x 1800mm
Marmox Multibond	300ml cartridge
Marmox S/A Waterproof Tape	100mm x 2500mm
Bath panel with adjustable feet	

Preparation

Ensure your bath has a sufficiently wide recess under the lip of at least 30mm, to fit the panel under the edges.

Fixing

- 1) Measure the end of the bath and cut the end panel to size. *(Make sure to leave a 30mm gap on outer edge for the side panel to sit in front of).*
- 2) Wedge panel under the end of the bath.
- 3) In the same way, cut to size and apply the side panel. *(Marmox Multibond can be used to stick the panels together where they meet).*
- 4) Tighten the adjustable feet.

End Panel - 800mm x 600mm x 30mm

Side Panel - 1800mm x 600mm x 30mm

Joints

Apply the Marmox S/A Waterproof Tape where the 2 panels meet each other and where they meet the wall.

Final touch

The Multiboard is now ready to be covered.

Tiles – Tile directly onto the board.

Boards
are ready to
plaster – there
is no need to
prime!

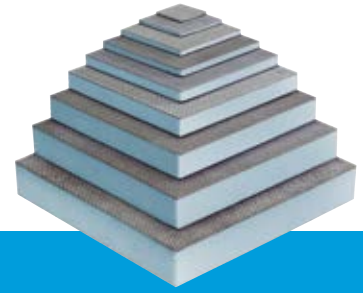

Multiboard - Dry lining

Marmox Multiboard is an all-in-one solution to Internal Wall Insulation. U value requirements for walls vary from 0.17 to 0.35 Watts/m²K depending on which part of the UK or Ireland you are in and whether it is a new build, an extension or a refurbishment. With non-insulated walls (solid wall construction), to achieve current new build levels of insulation with any internal wall insulation is extremely difficult but using Marmox Multiboard will significantly reduce the U value. For example, a typical solid wall will have a U value of 2.1 Watts/m²K but with a 40mm thick Marmox Multiboard this heat loss is reduced by 70% to 0.60 Watts/m²K

Depending on the condition of the wall, Multiboard can be fixed directly to the brick or blocks mechanically or using a cement-based tile adhesive. **Plasterboard adhesive is not suitable.**

Marmox Multiboard (10mm and thicker) is CE marked meaning that it meets the criteria proving that it significantly reduces heat loss through walls. The most popular thicknesses for internal wall insulation is 20mm and 30mm, which does not take up too much extra room space. Around door and window reveals thinner board such as 10mm or even 6mm can be used to reduce the risk of thermal bridging and condensation.

Preparation and installation

- If fixing onto battens, fix the boards (minimum thickness 12.5mm) with 300mm centres.
- Seal the edges together using a bead of Marmox Multibond.
- Cover the edges prior to plastering with reinforcing tape/scrim tape. (do not use waterproof tape under plaster).



SoundBoard - thermal and acoustic insulation

Marmox SoundBoard is a tile backer board which reduces the impact noise that passes through a floor into the room below. Like Multiboard it provides a completely waterproof layer, secure decoupling, thermal insulation and low compressibility but with the added benefit of effective impact sound reduction.

One side of the board is coated with a sound attenuating layer of SBR rubber that isolates the tiled surface from the floor so that there is nothing for the sound waves to travel through. The rubber compound is natural so there is no plasticiser migration ensuring the material neither shrinks, degrades or becomes brittle. SoundBoard will reduce the level of impact noise greater than the recommended minimum of 17dB.

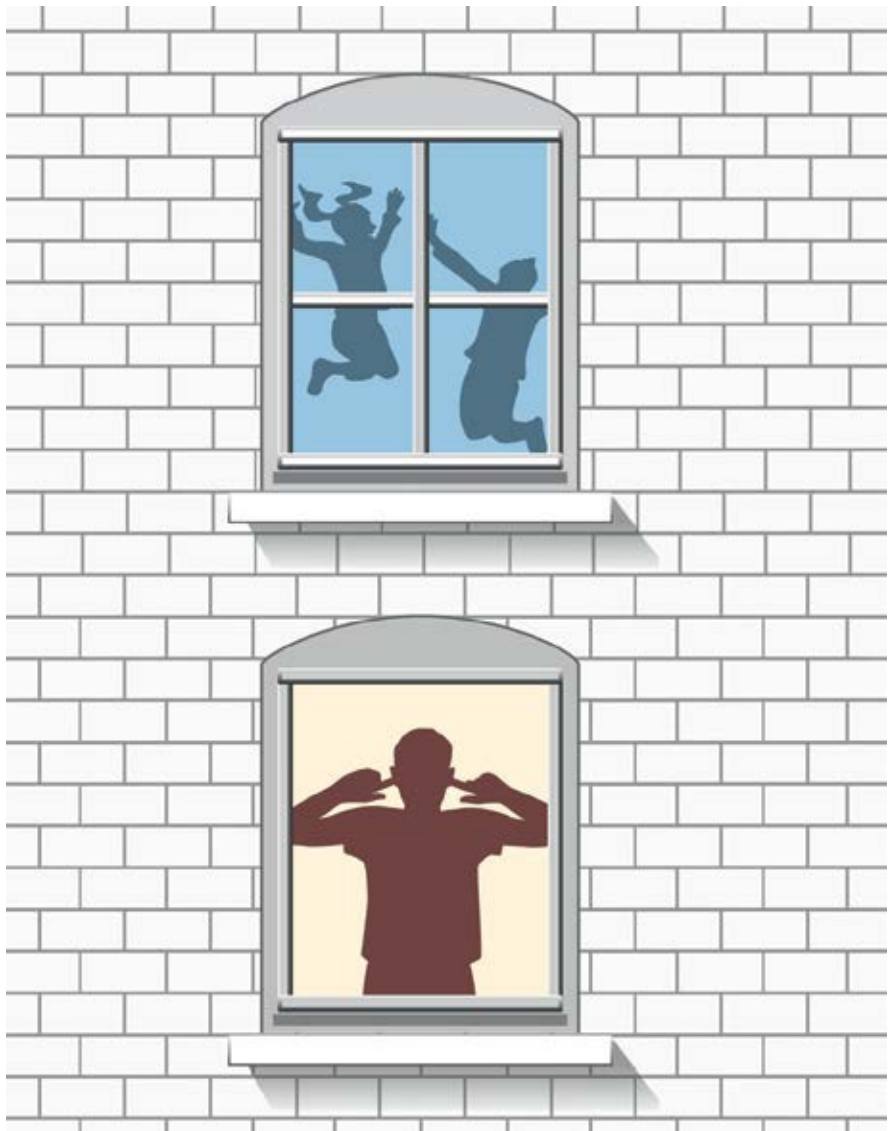

Meets local authority regulations for tiled bathrooms in shared apartments and flats



Technical data

Test

Thermal conductivity

Thermal resistance

Compressive strength to EN826

ΔL_w Weighted impact sound reduction to ISO 140-8

As above (with tiled surface)

Dimensions

Weight

8mm

0.042 W/mk

0.19 m² K/W

300 kPa

28 dB

20 dB

1250mm x 600mm

4.5kg

12mm

0.04 W/mk

0.30 m² K/W

300 kPa

28 dB

20 dB

1250mm x 600mm

4.9kg

- High thermal insulation
- Reduces impact sound
- Fully waterproof
- Use with under-tile heating
- Easy to cut
- Ready to receive tiles



Preparation

Make sure floor is dust and dirt free.

Note: Marmox SoundBoard should only be used on floors.

Fixing

1) Cut the boards to size leaving a 5mm gap between the boards and the walls.

2) Fix to the floor with the rubber side facing down using a flexible tile adhesive.

2a) If the floor is not going to get wet, an alternative method is to fix with Marmox Multibond (1 tube evenly spread over the rubber face of two boards).

3) Tape all the joints with Marmox Reinforcing Tape.

4) If using underfloor heating, apply the heat wire to the concrete surface of the soundboard.

For waterproofing be sure to tape all the corners and joints with Marmox Self Adhesive Waterproof tape instead of the Marmox Reinforcing Tape.

Tiling

The Soundboard can now be covered with tiles of minimum size 5cm x 5cm.

Under Laminate Flooring

When used with laminate flooring, the concrete face is fixed to the floor with Multibond, so that the rubber side is facing upwards in contact with the laminate.

Showerlay³⁶⁰

Marmox Showerlay360 is a tileable sloping base for a shower area, on either a wooden or concrete floor. Two options are available, a version which is supplied with a traditional square drain (point drain), or a 40mm thick version which has a stainless steel linear drain.

The square drain version has a brushed stainless steel grate housed in an integrated frame which can be adjusted to accommodate tiling thicknesses of from 5mm to 15mm.

The drain gully supplied can be adjusted from offering a vertical to horizontal outlet, or any angle in between. Depending on the angle of the outlet pipe, the flow rate is 30 to 50 litres per minute.

WARNING: Do not use solvent based adhesives/sealants with Marmox products.



- step-free access
- lightweight to handle
- reinforced for extra support
- ready for tiling
- centre or offset drainage
- can be cut down to size

A new compact drain, at just 80mm deep with a 50mm water seal, has been developed to work with both our Showerlay bases. The gully can be adjusted to make the outlet pipe horizontal, vertical or any angle in between.



Boarding lowered between joists

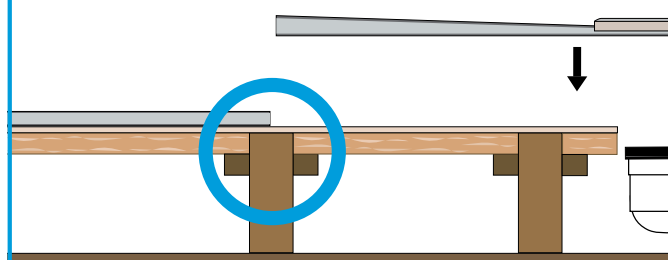

Standard floor on joists

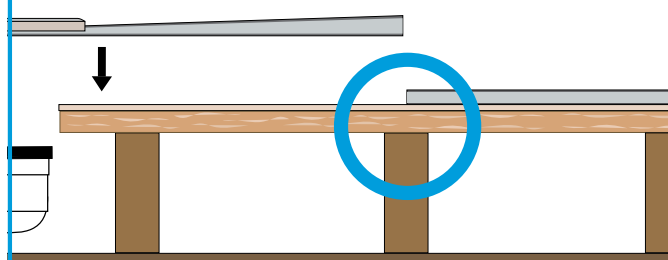



Point drain - Centre

size (mm)	perimeter (mm)	weight (kg)
800 x 800	20	3.50
900 x 900	20	4.20
1000 x 1000	20	5.00
1200 x 760	20	5.00
1200 x 900	20	5.20
1200 x 1200	20	7.00
1500 x 1500	24	10.50

Grate size: 120x120mm

Point drain - Offset

size (mm)	perimeter (mm)	weight (kg)
1000 x 1000	20	5.00
1300 x 800	20	5.20
1500 x 800	24	6.00
1200 x 760	20	5.00
1200 x 900	20	5.20
1200 x 1200	20	7.00
1850 x 900	24	8.50

Grate size: 120x120mm

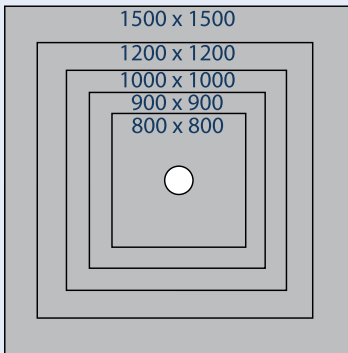

These 2 sizes are also available with centre drain position

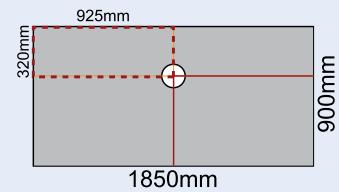
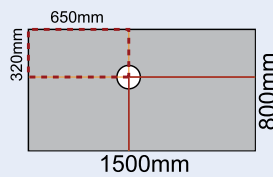
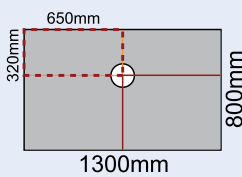
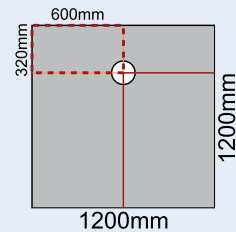
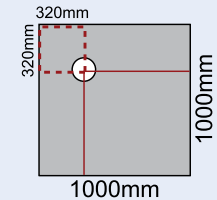
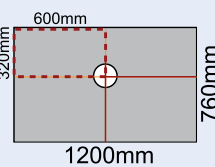
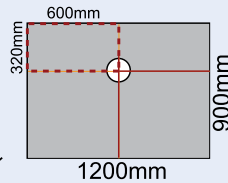

Linear drain - Offset

size (mm)	perimeter (mm)	weight (kg)
1200 x 900	40	6.0
1850 x 900	40	7.1
1200 x 1200	40	5.8
900 x 900	40	6.0

Grate size: 600x70mm

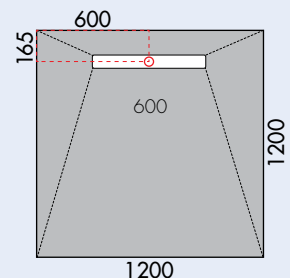
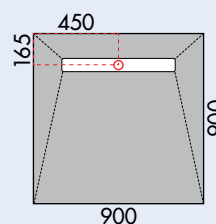
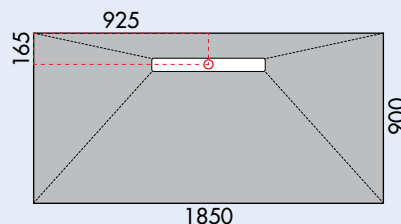
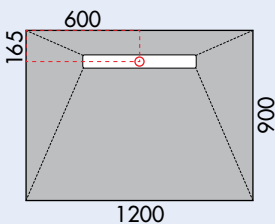

Showerlay³⁶⁰

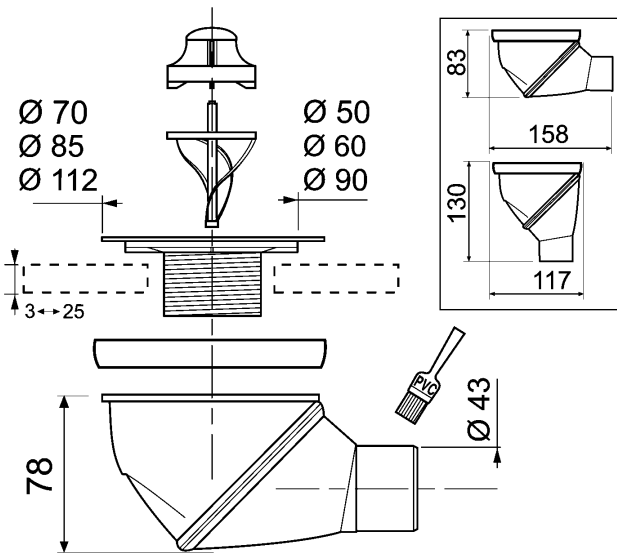

Fixing onto a wooden floor

The Showerlay needs to be fully supported and can be laid either onto the existing flooring or lowered to joist level. If lowering, a platform of 18mm plywood / chipboard should be installed between the joists.

- 1) Cut out a hole 130 to 150mm diameter where the drain is to be positioned.
- 2) Adjust the drain to the desired angle and solvent weld to a BS40mm pipe
- 3) Fix the Showerlay onto the timber with a continuous bed of cement-based tile adhesive.
- 4) The rubber sealing ring of the drain is pulled up tight against the underside of the Showerlay by screwing in the flange. This is screwed through the drain frame and tightened with the red 'key.'
- 5) "Tank" the joints with Marmox self-adhesive waterproof tape
- 6) **Square Drain version:** Thicker tiles require the spacer to be used. A threaded spacer ring is slotted onto the bottom of the drain frame to increase the length of the black thread and thereby allow the grate to sit higher. Do not use the spacer ring with tiles less than 10mm thick. The height of the point drain is adjustable by screwing in the insert holding the grate frame. Remember, the height of the grate will be slightly higher than the height of the grate frame, so this should be accounted for when considering the height of the tiles which should be flush with the top of the grate, not the grate frame.
Linear Drain version: Adjust the height of the drain cover by adding spacers underneath the channel body.
- 7) There is no need to prime the unit, simply tile with cement-based tile adhesive. If tiles are greater than 10cm, they should be cut along the lines from the Showerlay's corners to the corners of the drain.

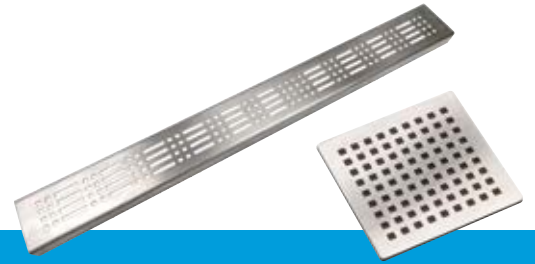

Fixing onto a concrete floor

The Showerlay needs to be fully supported from underneath.

- 1) Create a void for the drain and drain pipe at least 90mm deep.
 - 2) Twist the drain to adjust the angle of the exit pipe then solvent weld it to the BS40mm pipe.
 - 3) The diameter of the hole will be greater than 130mm, therefore in-fill with concrete. Set the height to the gully 3–4mm below the floor level.
 - 4) Fix the Showerlay to the floor using a cement-based tile adhesive.
 - 5) The rubber sealing ring of the drain is pulled up tight against the underside of the Showerlay by screwing in the flange. This is screwed through the drain frame and tightened with the red 'key.'
 - 6) "Tank" the joints with Marmox self-adhesive waterproof tape
 - 7) **Square Drain version:** Thicker tiles require the spacer to be used. A threaded spacer ring is slotted onto the bottom of the drain frame to increase the length of the black thread and thereby allow the grate to sit higher. Do not use the spacer ring with tiles less than 10mm thick. The height of the point drain is adjustable by screwing in the insert holding the grate frame. Remember, the height of the grate will be slightly higher than the height of the grate frame, so this should be accounted for when considering the height of the tiles which should be flush with the top of the grate, not the grate frame.
- Linear Drain version:** Adjust the height of the drain cover by adding spacers underneath the channel body.
- 8) There is no need to prime the unit, simply tile with cement-based tile adhesive. If tiles are greater than 10cm, they should be cut along the lines from the Showerlay's corners to the corners of the drain.

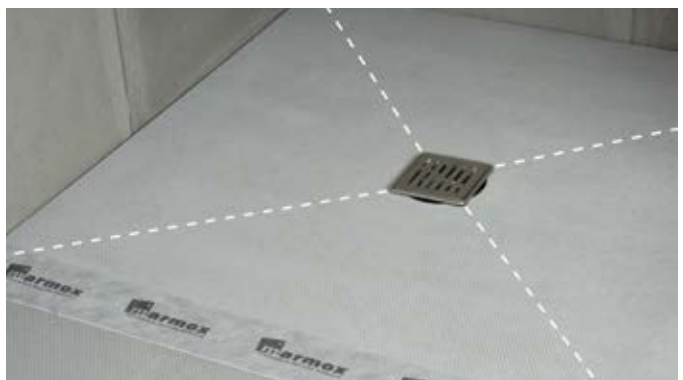

Niches

Our Niches are used to easily form a recess for toiletries within showers and other wet areas. They comprise of an extruded polystyrene core coated on either side with a thin but robust layer of fibreglass reinforced polymer concrete.

Marmox Shower Niches are fixed to the wall usually on a frame so that the front lip of the Niche is flush with the Marmox Multiboard on the wall. The joints between the Niche and the Multiboard are sealed together with Marmox Waterproof Tape.

FEATURES

- Completely waterproof.
- Provides thermal insulation.
- Ready to tile
- Lightweight and easy to work with.
- All niches are made with 12.5mm thick board and fit wall cavities 100mm or deeper.
- Comes already constructed which guarantees the conformity and the size.



400x200mm



400x300mm



400x400mm

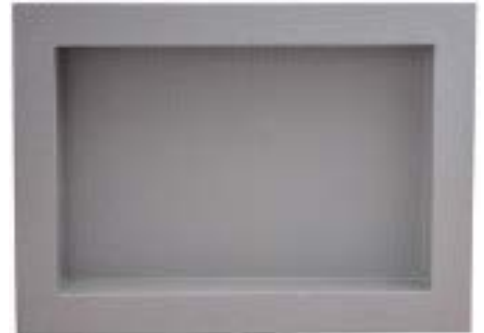

400x500mm

Product	Inside measurements	Outer measurements
Marmox Niche (MO56)	400mm x 200mm	500mm x 300mm
Marmox Niche (MO57)	400mm x 300mm	500mm x 400mm
Marmox Niche (MO58)	400mm x 400mm	500mm x 500mm
Marmox Niche (MO59)	400mm x 500mm	600mm x 500mm



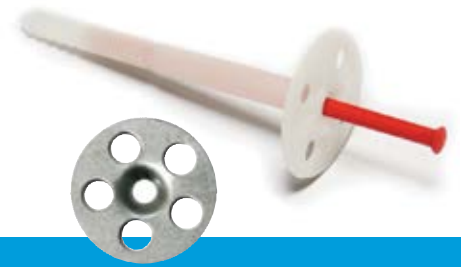

Marmox accessories

Marmox Plinth

- hides pipework
- ideal for concrete floors
- fully waterproof
- high strength
- easy to install

Raises shower base so no digging needed



For where it's not convenient to install a floor-level shower base because you cannot dig up the concrete floor, for example, if you live in a flat. An easier alternative to excavating beneath the shower area is to have the drainage above the floor. This would mean that the Shower base would be raised above the floor, and has previously been achieved by the installer fitting a timber frame to hold the shower former just above the drain.



Marmox Plinth is the simple solution to this problem. It is a 1500x1000mm piece of dense waterproof XPS that is 100mm thick, so therefore raises the height of the shower base by 100mm. This allows the gully and drainpipes to sit neatly inside it. It also provides a perfectly level surface which is necessary and difficult to achieve when make in a timber frame.

Marmox Plinth is suitable for use with our Showerlay range of products.

Marmox sealants and adhesives



Marmox MSP360

An ultra-high performance, clear adhesive and sealant providing instant grab, externally and internally. It is made using the latest Advanced Modified Silane-Polymer (MSP) Technology, meaning it can be applied to wet surfaces – and will even cure underwater.



Marmox Multibond

A completely VOC free white sealant and adhesive, for internal use. Based on an innovative Inert Polymer Technology (IPT) it is suitable for a wide variety of building trade applications.

OUR TANKING SYSTEM is a butyl based tape which will seal and waterproof joints between boards used in wet areas.

Marmox S/A Waterproof Tape – A butyl based tanking tape which will seal and waterproof joints between boards used in wet areas. Roll 100mm x 10m. For use with tiles or plaster.



Reinforcing Tape – A scrim tape to bridge all board junction (except those in wet areas). Available in 20m or 90m rolls. For use when plastering.



Plastic / Metal Washers – Required when screw fixing. Screw hole diameter: 5mm (plastic) / 6mm (metal).



Wall Bracket – A simple method of positioning boards, especially useful with pipe boxing board.

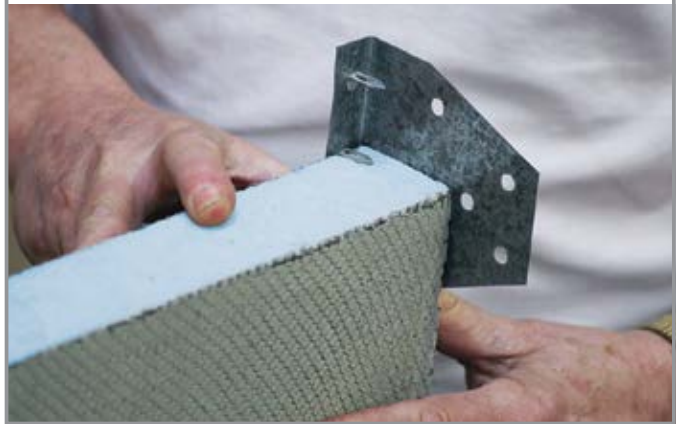

Fixing Dowels – A fast method of mechanically fixing the boards generally with the dot and dab method.



Waterproof Corner Pieces – A butyl based waterproof corner, for fixing with Multibond or tile adhesive.

Internal corner piece

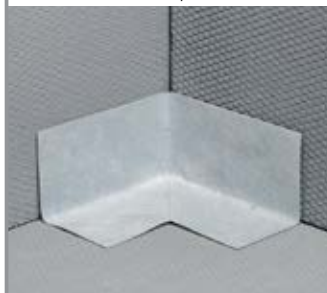

External corner piece



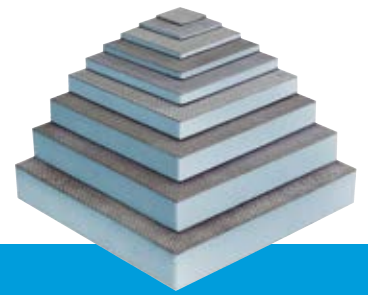

About Marmox

History

Founded in 1999, Marmox (UK) Ltd is a British company and an integral part of CMB-International; one of the world's leading manufacturers of construction chemicals and building materials. CMB was founded in 1981 and has grown to become one of the world's largest producers of extruded polystyrene.

Quality

All Marmox production is subject to the controls of ISO9001 and because our products are used globally they also conform to all European, United States and International standards where



appropriate. For the UK market, Marmox Multiboard is BBA certified as a tile backer board, and is CE marked as an insulation board. All Marmox products have a lifetime guarantee.

Warehousing

With large warehousing we are able to hold more stock than ever before. All sizes of all Marmox products are kept in stock and goods should be delivered within 2–3 working days. Most orders, however, are processed and dispatched the same day.



*“It’s what’s underneath
that counts”*

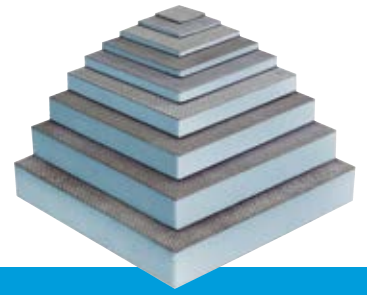



Caxton House, 101 - 103 Hopewell Drive, Chatham, Kent, ME5 7NP, UK
Tel: +44 (0)1634 835290 Fax: +44 (0)1634 835299
Web: www.marmox.co.uk Email: sales@marmox.co.uk